

# SOUTH PACIFIC PERFIN BULLETIN

NO. 74 JULY 2006

The South Pacific Perfin Bulletin is published by the Perfin Club of New Zealand and Australia four times each year. Club subscriptions (including payment for the Bulletin) are A \$10-00 p.a. for New Zealand and Australian residents and A \$15-00 p.a. for residents of other countries (including airmail postage). Back issues available from Secretary.

---

President: Dr Derek Pocock, PO Box 670, Subiaco. Western Australia 6904 Australia

Secretary: John Mathews, 21 McConnel Cres, Kambah ACT 2902, Australia

email – john.mathews@canberra.edu.au

Treasurer & Librarian : David Coath, 4 Fleming Court, Research, Victoria 3095, Australia

Email – davidcoath@onthe.net.au

Assistant Treasurer (NZ payments): Richard Smolnicki, 19 Oakleigh Street, Maungaraki, Lower Hutt, New Zealand

Editor: David Andersen, 260 Hawkesbury Rd, Winmalee NSW 2777, Australia

email- d.andersen@library.usyd.edu.au

Circuit Managers:

New Zealand Ray Bennett, PO Box 354, Timaru, New Zealand

Australia John Mathews, 21 McConnel Cres, Kambah ACT 2902, Australia

---

## EDITOR'S COMMENT

There has been good progress with the draft for the 2<sup>nd</sup> edition of Australian Official Perfins. The main area that needs to be finalised are the OS issues on Queensland, South Australia, Victoria and NWPI as I have neither the collection, nor am I aware of references that will provide the information needed. It would, however, not surprise me to find that references exist for these areas and I would appreciate being advised of these. I have put together a 12-page listing of the issues from these areas that I am aware of and hope that some members may be able to add further information. I can send this list by either mail or email. If you would like to help please ask for a copy. I would hope to get additional information by the end of September 2006 so that we can finally get this new edition produced.

David Andersen

---

## NEW MEMBERS

We welcome the following new member who has joined since the previous issue:

#230 Stewart Aylett, Footscray, Victoria

---

## THIS MONTH'S CLUB AUCTION

Bidding was again early and strong on all sections of the auction. It was particularly pleasing to see several new vendors and bidders this time. There were many especially nice items and the competitive bidding on them has resulted in price levels being established for this material.

## CHANGE OF TREASURER

We regret to inform members that, due to ill-health, Peter Wood has had to resign from his position as Treasurer of the Club. Peter has been Treasurer since 1991, and has maintained accurate records and provided sound financial advice to the Club. As a result, the Club is in an excellent financial position.

David Coath has accepted an invitation to take over the position of Treasurer, and we thank David for volunteering to do this. Members should note David's address on page 1 of the Bulletin for forwarding of subscriptions, etc, to the Treasurer.

We wish Peter a well-earned rest and a speedy return to full health.

## OUR PERFIN CLUB'S 20<sup>TH</sup> ANNIVERSARY

The Perfin Club of New Zealand and Australia was formed in 1987 and will celebrate its 20<sup>th</sup> anniversary next year. Members are invited to submit ideas to the Secretary for ways in which we can celebrate this milestone. These may include events, competitions (for prizes??), etc. National exhibitions in our region next year will be held in Sydney, New South Wales, in June, and in Hutt Valley, New Zealand, at the end of August. We will have meetings for Club members and visitors at each of these.

## A CLUB MEMBER'S WEB SITE

Dave Elsmore has created a web site of special interest to those who like revenue stamps of all kinds, at <http://www.users.bigpond.net.au/dave1/index/> It also features a couple of very nice perfin items.

## PERFIN CLUB OF NEW ZEALAND AND AUSTRALIA

Statement of Receipts and expenditure for the year ended 30 June 2006 (New Zealand account).

Receipts (NZ\$)		Expenditure (NZ\$)	
Bank Balance 1.7.05	149.60	Auction vendors	21,70
Circuit book sales	1330.75	Circuit vendors	59.80
Subscriptions	509.76	Transfer to Aust. A/c	1804.76
Interest	10.65	Postage	68.81
Auctions	141.40	Miscellaneous	22.24
Catalogue	90.00		
Miscellaneous purchase	60.00	NORTHPEX exhibition	150.00
		Bank balance 30.6.06	<u>164.85</u>
Total	<u>2292.16</u>	Total	2292.16

Our thanks to Richard Smolnicki for his good work in managing our NZ account.  
PERFIN CLUB OF NEW ZEALAND AND AUSTRALIA

## PERFIN CLUB OF NEW ZEALAND AND AUSTRALIA

Statement of Receipts and expenditure for the year ended 30 June 2006 (Australian account).

Receipts (A\$)		Expenditure (A\$)	
Bank balance 1.7.05	12817.21		
Subscriptions	1855.60	Bulletins	1536.10
To members' credit	3873.25	By members' credit	3562.55
Bank interest	1.49	Bank & Govt charges	18.20
Exchange Branch	13088.80	Exchange Branch	13106.50
Auction 1/05	4426.55	Auction 1/05	4627.25
Auction 2/05	1475.95	Auction 2/05	1401.15
Transfer from NZ a/c	1500.00	Postage & Stationery	424.95
Interest, Term Deposit	606.00	T'fer to Term Deposit	2000.00
Handbook sale	58.85	Donation (StampShow)	75.00
		Souvenir covers	130.00
Miscellaneous <sup>(1)</sup>	1809.95	Miscellaneous <sup>(1)</sup>	1809.95
		Bank balance 30.6.06	12722.00
	-----		-----
Total	41413.65	Total	41413.65

Note: (1) Contra entries for duplicate cheque reimbursed.

<u>Term Deposit</u> - Balance 1.7.05	\$12,000		Bank balance per statement	9986.30
Added	2,000		Plus cheques not deposited	2735.70
	-----			-----
Balance 30.6.06	14,000		Reconciled balance 30.6.06	12722.00

Our thanks to Peter Wood for his good work in managing our Australian account for over 15 years. Also thanks to David Coath for taking over from Peter and preparing this financial statement at short notice.

---

#### TATTERSALL'S SWEEPSTAKES – A SOCIAL BAROMETER (John Mathews)

While horse racing has been named "The Sport of Kings", that title really only reflects the social group who can afford to own racehorses which take part. The gambling side of horse racing, as indeed of all forms of gambling, really relies on people's hope to "beat the odds" and perhaps even make one's fortune. It is probably true that Tattersall's Sweepstakes, which grew out of the economic depression of the 1890s, appealed largely to those desperate folk who tried to win a small fortune.

Recently, I bought a perfin item on eBay which seems to reflect such a situation. It is a part cover front used in July 1904, with a 2d Tasmanian Pictorial with perfin A.2. On the reverse of this front is the following message:

"Mr. Addams  
 Plis sur send me one ticit on the Metropolitan Stakes run about September  
 12, 1904.  
 Yours truly," (name withheld – jhm)

The address seems to be a remote rural location, which I have not been able to find on either modern maps or gazetteers of the time.

For those who like all the details, the Metropolitan Stakes run in Sydney on Monday, September 12, 1904, was won by 4-y-o chestnut gelding "Alias", a 100-to-1 outsider, ridden by W. H. Smith and owned by Mr. James Chambers. Second place went to "Tartan" (4-to-1), and 3<sup>rd</sup> was "Cato" (25-to-1). The winner's prize was £2,480.

## FUNNY BUSINESS IN WA

(David Andersen)

David Coath has been given access to some information from the late Kevin Bliss's collection during its sale. He returned one of my letters to Kevin in 1992 relating to a number of perfin related issues plus a number of other documents of interest.

To me the most interesting item was a receipt from John Shaiak the Sydney Dealer in March 1952. The receipt was for

"Selected lot KGVI punctured W.A. mint (some imprints) incl. 3 copies  
3d blue, Face value £5.12.0 ON APPROVAL £6.5.0.

Herewith another nice lot. Now we have only a small lot left. Should you still be interested please let us know and we will send the balance on approval. "

Considering that the WA perforator continued in use until 1954 the sale of this material which was still in use by Western Australian Government Departments is intriguing. Over the years there has been a fair number of KGVI mint issues, many in imprint blocks, for sale. Evidently there was a degree of interest in the W/A officials in the early 1950s. The range of mint material available is quite large. I remember purchasing a lot of mint WA perfins at auction in the early 1980's for around face value, including 18 different imprint blocks.



While we may never know how this mint material reached the public arena one does wonder if its existence is totally legitimate. There was also other funny business going on with the Western Australian issues around that time. George Owen records that almost all of the commemorative stamps from the 1½d Canberra onwards were punctured W/A at the request of a member of the Armed Forces of a certain Allied Nation in 1949. These "per favor" issues are encountered in mint condition and are quite scarce and were definitely not issued for Departmental use. It does appear that this person did not retain all of the issues so punctured as some have turned up in Australia since then. It would be very interesting to find out who this person was and what happened to the material punctured.

## AN UPDATE ON THE PERFIN ON THE 1927 CANBERRA ISSUE

Thanks to all those members who forwarded information on other patterns on the 1927 Canberra issue (see article in SPPB, January 2006, page 2). The information has been passed on. Additional patterns reported are:

A.9,	AE.1,	AECO.1,	AICO.1,	AS&S.1,	A+R.1,
B.9,	BMC.1,	B&N.15,	BP.6,	BS&F.9,	C.1,
CMCO.1,	DC&CO.1,	DJF.1,	DUN.1,	DWMLTD.1,	
DWMLTD.2,	DWMLTD.4,	ECS.1,	ED&CO.2,	EFCS.1,	ET.7,
F.1,	FG.5,	G.1,	GAS.2,	GDCO.1,	GT&CO.1,
GW.1,	HB&CO.2,	HS.4,	IDH.1,	IOA.2,	J&B/S(.21?),
JC&COLTD.1,		JCH.2,	K.4,	KBW.4,	KL.1,
LL.2,	LLG.5,	LLG.6,	M.9,	MMICO.2,	NB.1,
NUF.1,	OK.3,	OK.4,	PD&CO.1,	PL&B.11,	PL&B.12,
PTCO.2,	QICO.1,	R.1,	R.2,	RA.4,	RICO.1,
RICOLD.1,	RR&CO.1,	S&A.2,	SG.2,	SH&CO.1,	TB.8,
TBS.2,	TTEA.1,	TYSLD.1,	VPC.3,	WDC.1,	WILLS.3,
Y.1					

## PERFIN COMMEMORATIVE COVER ON eBay

The cover illustrated was produced by Angus & Robertson, booksellers and stationers, of Castlereagh Street, Sydney, to promote the book "The Shackleton Expedition to the South Pole". It has a machine cancel date of July 3, 1909. The ½ d green stamp has perfin A&RLTD.1.

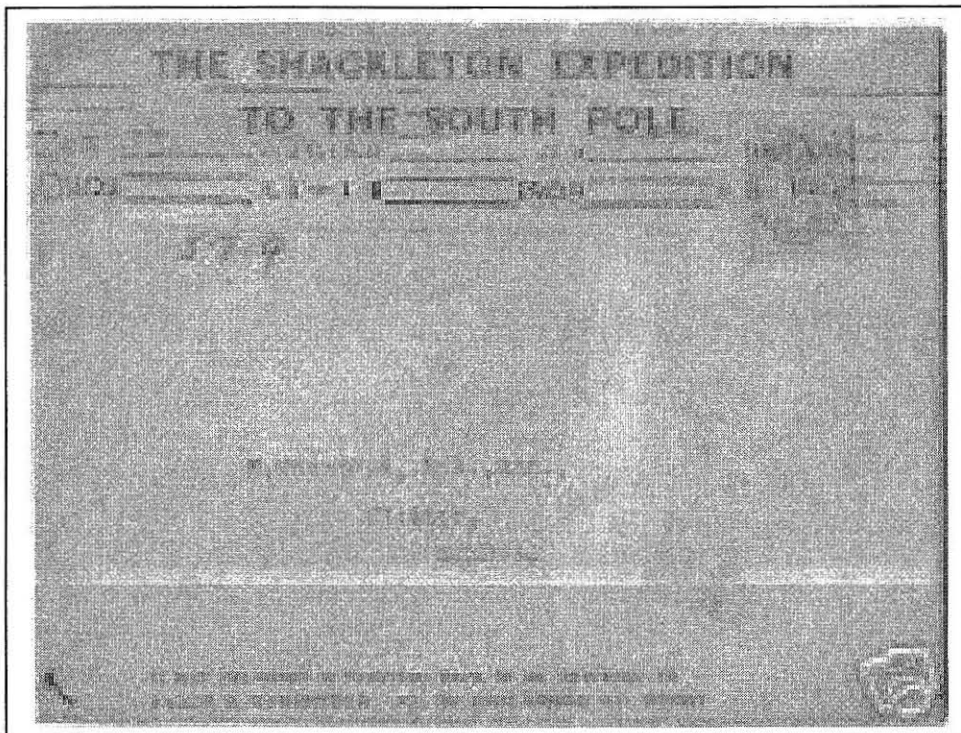

## McP.2 – MISSING PINS, AN UPDATE (Ken Killeen)

Ken has submitted an update to his study on the gradual degradation of this perforator, adding some new transitional states and some new dates. The original article was published in SPPB, Jan 2006, page 11.

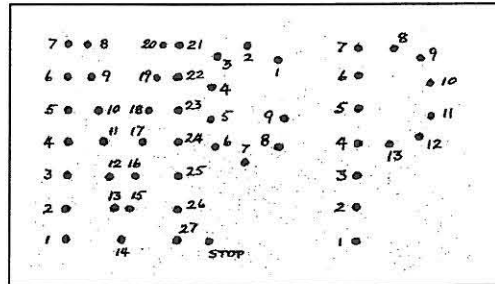

State	Missing pins	Dates
1	(Complete)	
2	M.14, 27.	New early date 13 Sep 09
3	M.1, 14, 27.	
4	M.1, 4, 14, 27.	From Nov 1910
5	M.1, 4, 5, 14, 27.	
6	M.1, 2, 4, 5, 11, 14, 26, 27.	
7	M.1, 2, 3, 4, 5, 11, 14, 18, 26, 27. C.4 P.3, 12	
8	M.1, 2, 3, 4, 5, 11, 14, 17, 18, 26, 27. C.4 P.3, 12	Only known date 7 Dec 1912
9	M.1, 2, 3, 4, 5, 11, 14, 16, 17, 18, 26, 27. C.4 P.3, 9, 12	Circa 1914

## ANOTHER PATTERN WHICH HAD SEVERAL PERFORATORS (John Mathews)

The pattern HSCO.1 of Howard Smith Co. Ltd., shipping agents, is listed in the catalogue as being used in the Commonwealth period, and in all States except Tasmania. Initially, this was thought to be the result of a single perforator in (head) office being used to puncture stamps for the various branches. However, closer inspection shows some consistent very minor variations in pin positions which suggest that each branch had its own perforator. The dies were no doubt produced from the same master template.

For those who wish to test their eyesight, the following are differences which I have discerned from enlarged images of many examples.

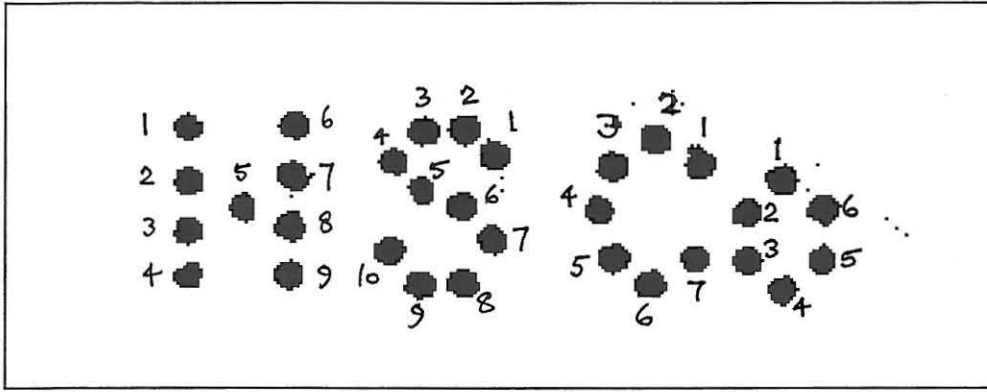

Victoria – top pin of left leg of ‘H’ bows slightly inwards (in all other dies, it is straight)

- the ‘o’ is slightly shorter.

South Australia - the ‘H’ is slightly further to the left than for the other States.

- pin S8 is slightly to the right compared with the others.

West Australia – the ‘o’ is slightly further away from the ‘C’ than for the others.

- the pin C6 is positioned slightly higher.

I have not been able to identify any differences between the Newcastle and Brisbane strikes. The die illustrated is the Newcastle die.

[Note: I cannot take any responsibility for any adverse effect on readers’ eyesight as a result of them trying to verify the above..☺]

## CHRISTMAS PERFIN FROM CANADA

Illustrated below is a perfin-like emanation from Canada. While not a commercial or government perfin is still rather spectacular and I couldn’t resist including it in a bulletin issue.



## WHAT IS IT?

The item shown was recently sold on eBay. It looks like a stamp, but without any country indicated and no “currency”. The inscription “POKO” (“POKO” stands for “Porto Kontroll”) is consistent with the POKO-style letters of the “MS” perfin, and the cut top and bottom edges of the stamp. Such stamps were perforated by the Michelius stamp vending machines.

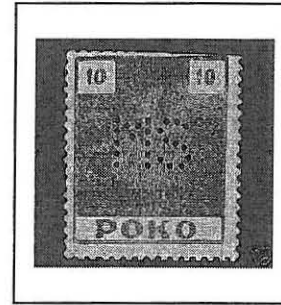

The item could be a significant piece of perfin history, and this is also suggested by the final selling price of US\$231!

## AN ITEM OF POSTAL PERFORATING HISTORY

Bryan Magee has reported an photograph of philatelic interest which was in the May auction of Charles Leski (Melbourne). The lot is described as a 23 x 19 cm 1880s albumen photograph showing a man operating a perforating press. The photograph was entitled “GPO Stamp Branch” and was listed under the “Great Britain” section of the auction catalogue. Indeed, the lettering on the top of the box in the foreground appears to be “STAMP BRANCH”. The mechanism is treadle operated and is very similar to that of the Australian “VG” perforator owned by your Secretary. The perforating head structure also looks similar to two other line perforators seen several years ago.

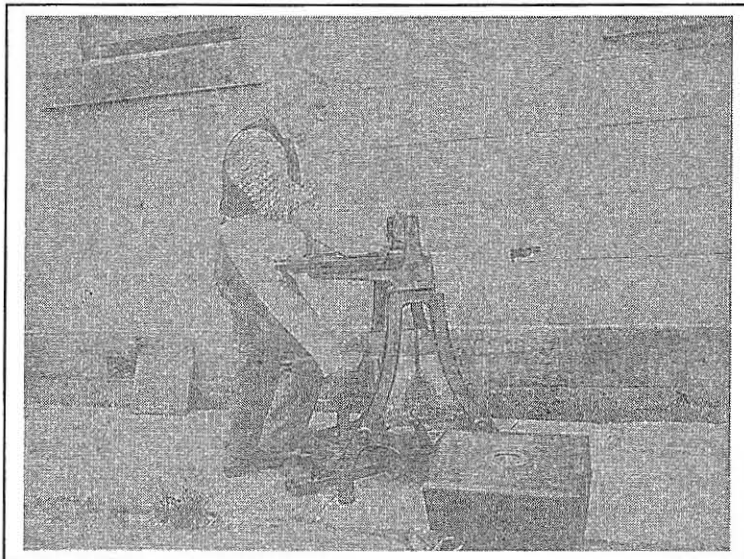

If the device was operated by the GPO Stamp Branch, it is most likely to be a line perforator, but also it could have been one used to perforate one of the GB official perfins. Peripheral points of interest are that the pieces of paper punched out appear to drop into nothing more “technical” than a cardboard carton; and no-one bothered to remove the weeds at the edge of the path to the left of the operator’s foot before the photograph was made!



## A COMPANY DATE CANCELLING PUNCH

The stamp shown was recently sold on eBay. The stamp is a Victoria 1d Duty Stamp, with manuscript cancel "14/2/83". The punch pattern is typical of many produced by Joseph Sloper & Co. of London, with the company initials surrounded by the date, day to the left, month to the right, and year underneath. The date and month could be changed using a set of removable dies supplied with the perforator, while the year die was produced as a separate item on request as part of Sloper's on-going business. The letters on this punch are "O/B.C" and the date is ".2/.83" (probably 12/2/83), consistent with the cancel.

The Oriental Bank Corporation was established in India by British interests, on the strength of usage of silver in that country at the time. The British tried to maintain silver as the standard in that area, rather than gold as elsewhere.

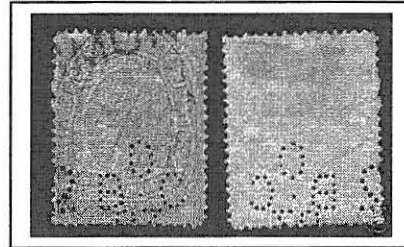

Eventually this bank went into liquidation at various times in different countries. In Melbourne, it had been at 50 Collins Street West in the 1870s, but went into liquidation in 1885 with the liquidators operating from 30 Queen Street for a couple of years after that.

## PERFIN CTCO ON CUSTOMS DUTY STAMPS – AN UPDATE (John Mathews)

Thanks to submissions sent in by Bill Harley, Peter Wood, David Coath and eBay, the previous article on this subject in the October 2005 issue (page 3), based on examples held by Ken Killeen and myself, can now be updated to give time sequences for seven heads of this multi-head die. As the perforator was no doubt manufactured by The Cummins Co. of Chicago, it is most probably a 10-head device (model 53 – see illustration in SPPB April 2006, page 8). Any further examples from members will be welcome to try to complete the details.

In the "tree" shown, time increases downwards and the vertical background lines approximately align the position of the upright of the letter 'T' in each pattern. The one exception is for M.13/W.1 where the images are spread to show the adjacent edges of what might have been adjacent stamps! Some of the patterns have had to be traced as photocopies were too dark to reproduce as they were. Also, where patterns were obtained from scans the scaling might not be exactly consistent with other patterns. The outline boxes for each pattern show approximately how much overlap there is between the various strikes which enabled horizontal associations to be made. The overall link between the heads is given by the sequence K.13 – K.11 – H.1 – K.1 – K.6. Unconnected boxes between the various columns in a given row do not infer that they were in existence at the same time. As rows become more complete this detail may emerge.

The contributors' numbering has been preserved, with letters indicating the contributor as follows:

K – Ken Killeen, H – Bill Harley, W – Peter Wood, C – David Coath.

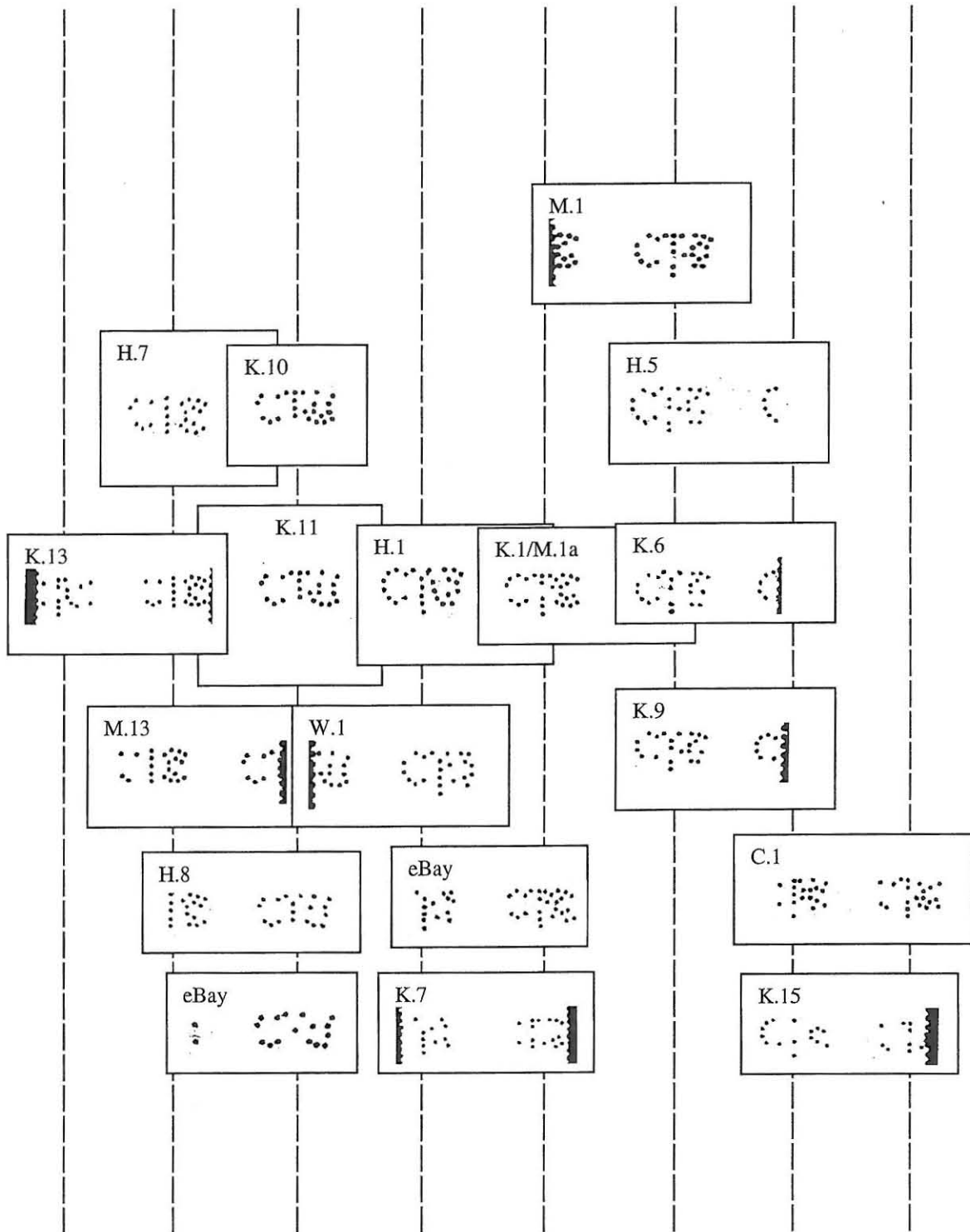
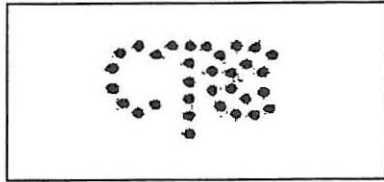

Progressive degradation of the heads of the "CTCO" die used in London on Australian Customs Duty Stamps

## A CURIOUS DOUBLE PERFIN STRIKE

Member David Coath has shown the item illustrated. Previously known double strikes (2 different patterns) are few, and have always been two Victorian Service Punctures, which is easy to explain. However, David's example has WILLS.1 and PL&B.12, both customized perforators. The question is, "How could this happen?" One answer might be that the companies did not actually have the perforators at their premises, but paid an agent to purchase the perforating dies and do the perforating for them, as Miss Dore Lough did for several companies in Sydney.

Another explanation might be that one company somehow perforated the stamp from the other's incoming mail. However, I think this rather unlikely. The strikes are both from the reverse of the stamp (a 1d green KGV, single wmk).

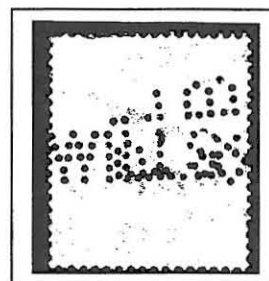

Any other theories?

## A NEW IDENTITY – OR A PERFIN MYSTERY? (John Mathews)

In June, I was very keen to get the item shown which was offered on eBay, as the envelope was of W. Watson & Sons Ltd of Melbourne, suppliers of X-ray and optical equipment, and they were not a known perfin user. The vendor had kindly sent me a detailed scan of the stamp area, which showed perfin pattern VB.2, and none of the "VB" perfins had a known user.

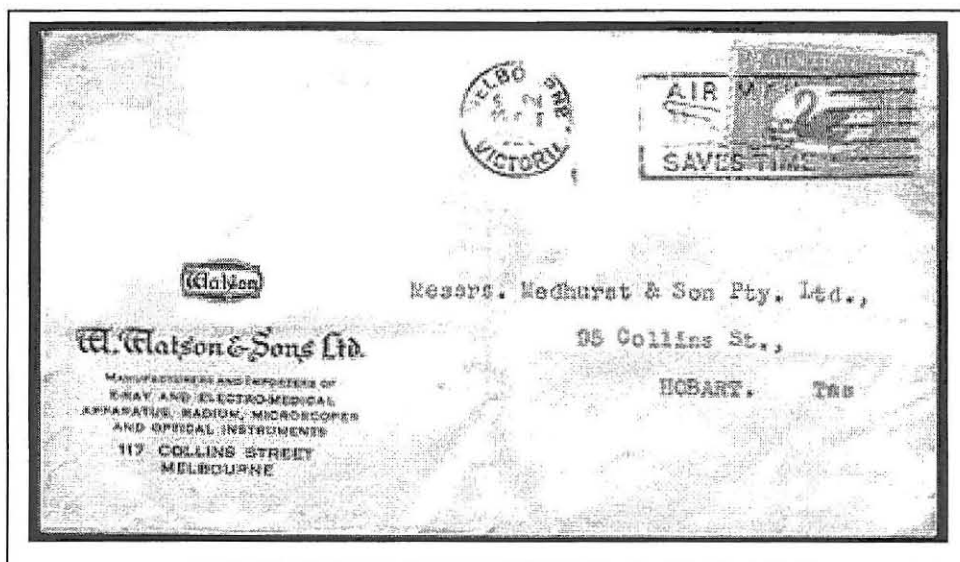

However, a search of Melbourne Directories from 1920 to 1930 (the range of use of the various "VB" patterns, including this cover) revealed no association between the firm of Watson & Sons and any trade mark or brand, nor of any other firm with which they may have been connected either by business or as neighbours in Collins Street. The most obvious user of "VB" could be Victoria Brewery, but .. ?? Does any member have any theory about this?

(I was outbid in the last seconds and the cover went for US\$66.)

## AUCTION WATCH

Items of perfin interest from auctions/direct sales since the last Bulletin include the following. Thanks to Tony Nobilo, Bryan Magee and John Amiet for passing on their spotting of perfin lots in auctions. Prices in A\$ unless indicated.

			Est.
a.	Tasmania 5d Numeral Stamp Duty perf DWMLTD.	(eBay, Apr 06) sold for	US \$ 22
b.	1934 large env from Official Secretary, Australia House, London, with KGV 1/-, 6d & 1½d pr, all perf "C/of/A"	(Status auction, May 06) sold for	\$400
c.	1954 cover of Burns, Philp & Co Ltd to USA via BOAC with 2/- Royal Visit stamp perf BP.6.	(eBay, May 06) sold for	US \$ 36
d.	Tasmania 1940 Stamp Duty, 9d overprint, rouletted, perf LLG.3.	(eBay, May 06) sold for	US \$256
e.	2 covers of the Commonwealth Wool & Produce Co Ltd with different KGV stamps with C.1 perfins.	(eBay, May 06) sold for	\$ 55
f.	Accumulation of c.800 private and official perfins on mainly Australian States, Roos and KGV issues.	(Gibbons, Melb, sale May 06) sold for	\$825
g.	1909 cover of Angus & Robertson advertising the book "Shackleton Expedition to the South Pole", with 1d NSW defin perf A&RLTD.1.	(eBay, May 06) unsold at	\$ 99
h.	6d engraved Kooka with perf GT&CO.1. Fiscally used.	(eBay, Jun 06) sold for	\$ 31
i.	Pair of 1/- black ANZAC perf "G/NSW", used.	(eBay, Jun 06) unsold at	\$ 30
j.	1906 cover front of The "Flinders Lane" Umbrella Factory, Melbourne, with 3d QV perf PL&B.24.	(eBay, Jun 06) sold for	\$ 30
k.	1920 cover front of J. & B. Sniders, Melbourne, with 1 ½ d KGV perf J&BS.9.	(eBay, Jun 06) sold for	\$ 20
l.	Victoria £1 salmon KEVII, perf 12 ½, perf "OS". Commercially used, "Market Street, Melbourne" pmk.	(David Holmes sale, Jun 06)	NZ \$100
m.	South Australia issues perf "SA". 2/6, 5/- and £1 values mint.	(eBay, Jun 06) sold for	US \$161
n.	Victoria KEVII £1 and £2 perf "OS" CTO.	(eBay, Jun 06) sold for	US \$207
o.	New Zealand vert pr 1935 2/- Cook perf RICOLD. Commercial cachet identifies company.	(eBay, Jun 06) sold for	US \$ 20

## FRENCH POSTAL STATIONERY CARD, PERFINNED

Perfined postal stationery items seem to be scarce for any country. The item shown was sold on eBay for US\$44. The perfin pattern is "PO", but from the message on the reverse, it seems that it was used privately. The black around the edge is background, not a mourning border.

